



POWERSTAR TRUCKS INDUSTRY CO., LIMITED

POWERSTAR Wrecker Truck with Crane

User's Manual



POWERSTAR TRUCKS INDUSTRY CO., LIMITED

<http://www.isuzutruckscn.com/>

Wrecker Truck with Crane

OWNER'S MANUAL

Preface

Thank you for purchasing POWERSTAR TRUCKS products. For better using your ISUZU Road Wrecker Truck with Crane, get the best operating performance, we strongly suggest that before the operation process you could read this manual instructions carefully, and to manipulate the program handily.

The manual detailed describes the performance of wrecker truck with crane, structure, usage, precautions and maintenance of such knowledge. While showing details of the truck, both pictures and description will together help you get better understanding of how to use truck. Before the operation, the skilled operator should carefully read the contents of the manual.

After master the truck performance characteristics, methods of operation and precautions, then could start to operate this rescue truck. In order to ensure the staff turnover after the operation, and properly use of the truck. This manual book must be properly kept, shall not be lost and damage.

----POWERSTAR TRUCKS

Contents

Chapter 1. General Description	5
Chapter 2, Main Technical Data	6
Chapter 3, Wrecker Truck with Crane Structure Components	7
i , 5 Tons Knuckle Boom Crane	7
ii ,Wrecker Platform Structure Components	8
Chapter 4, Wrecker Truck with Crane Working Principles	11
i , How is the wrecker truck with crane working?	11
ii How to operate wrecker truck with crane?. (Very Important)	12
Chapter 5, Others for Attention	18
Chapter 6, Troubleshooting	20
Chapter 7, Accessories	21

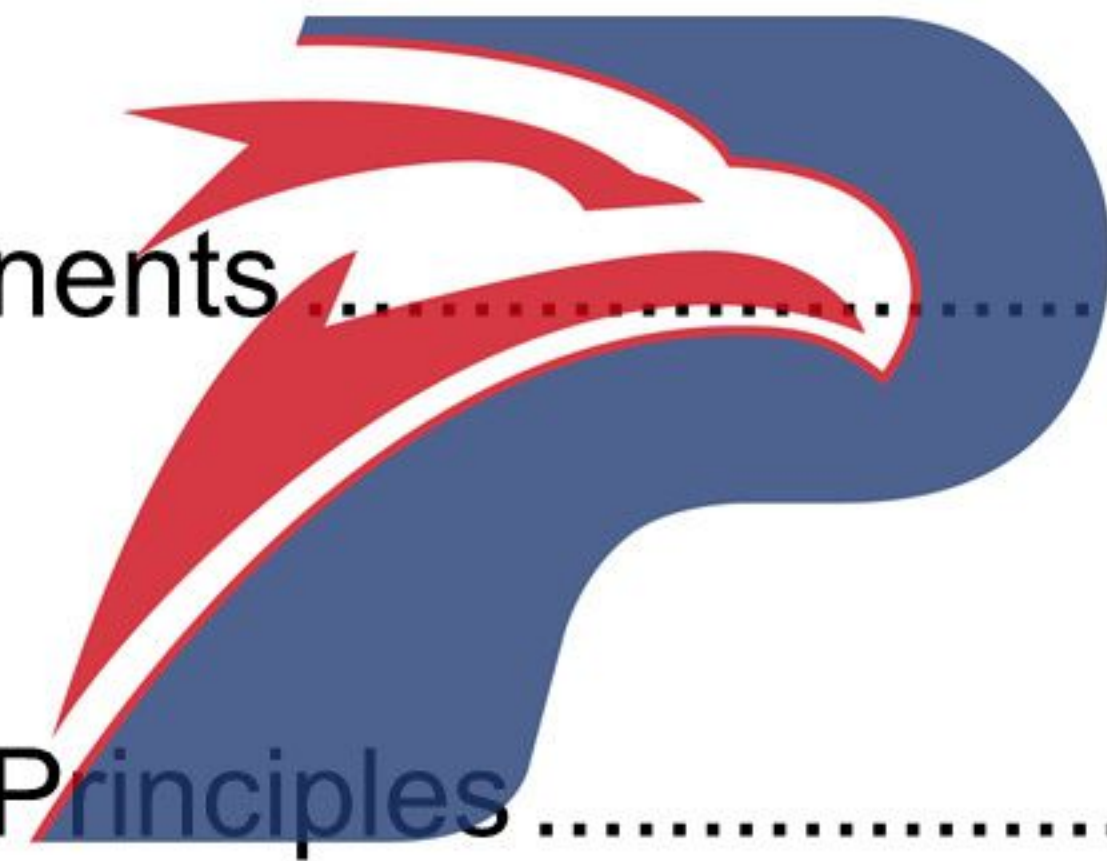

POWERSTAR

Chapter 1. General Description

POWERSTAR TRUCKS Wrecker Truck with Crane based on type II ISUZU chassis, which consist of 5Tons XCMG knuckle boom crane & over 7m rescue platform, mainly used for road rescue working, and the working aerial can be City Street, factory and other areas of need.

*The vehicle designed to fully rely on the advantages of the original 4*2 long wheelbase chassis, fully consider the product's convenience and features. The 5Tons knuckle boom crane is supposed to take up little space but with multi-function performance. The rescue platform can be laid down to deliver all kinds of vehicles, with wire rope and tape to fasten the vehicle during delivery, which is multifunctional enough to cover all customers' requirement.*

POWERSTAR

The ISUZU 4x2 Wrecker Truck with Crane equipped with Knuckle crane, long rescue platform, hydraulic cylinders and English version operation guidance. Therefore, the vehicle is an ideal truck mainly for motor vehicles transportation & vehicles that broke down.



(Preview for your ISUZU Wrecker Truck with Crane)

Chapter 2, Main Technical Data

Basic parameter:

Items		8Tons ISUZU Wrecker Truck with Crane
S I Z E	Outer Dimension (L×W×H) (mm)	9800*2500*3300
	Wheelbase (mm)	5550
Kerb Weight (kg)		8780
G E A R	Gearbox brand	FAST
	Model	ISUZU MLD 6-shift gearbox
	Type	Manual
Cab capacity (includes driver)		2
E N G I N	Model	ISUZU 4HK1-TCG40
	Type	Four cylinder inline, four stroke, water-cool, turbocharged Inter-cooling, diesel
	Rating Power (kW/HP)	140/190
	Emission Standard	Euro 4

Note: 1. The vehicle height includes Knuckle Boom Crane.
 2. We keep the right to revise the parameters on the list above.

Superstructure parameter list

Items		Parameter
Knuckle Crane	Capacity (Tons)	5
	Max Lifting Moment	10.5 T.M
	Max Hydraulic Outreach	8.01 m
	Slewing Angle	370°
	Slewing Torque	1.58 T.M
	Stabilizer Spread	5210 mm
	Fitting Space Required	1100 mm
	Width Folded	2480 mm
	Max Operating Pressure	28 Mpa
	Recommended Pump Capacity	25 L/min
Wrecker Platform	Platform Dimension	7100*2300
	Control	Hydraulic Manual control
Remarks		All basic necessary accessories. Tool kit
More details for wrecker truck with crane showing as below		

Chapter 3, Wrecker Truck with Crane Structure Components

i , 5 Tons Knuckle Boom Crane

Side view for ISUZU wrecker truck with crane:



Wrecker Platform system

5Tons Knuckle boom crane

ISUZU chassis cabin

The 5Tons knuckle boom crane use famous XCMG brand, with new model SQZ105-3. This consists of hydraulic arms, rotation seat, hook, hydraulic landing legs, operation joysticks, etc.

5Tons knuckle boom crane mounted on ISUZU chassis



www.isuzutrucks.cn.com

ii ,Wrecker Platform Structure Components

This wrecker truck use 8Tons folding platform, which mainly consist of below system:

1. Pillow alarm light and fixture (including cabin alarm system)
2. High position traffic signal indicator light at two sides
3. Capstan and rope
4. Platform
5. Side warning lamps
6. Wheel bracket
7. Operation Joysticks
8. Side fence
9. Tool box and accessories



1. Pillow alarm light and fixture (including cabin alarm system)
Light uninstalled, as package in cabin

www.isuzutrucks.cn.com
Pillow alarm light



2. High position traffic signal indicator light at two sides

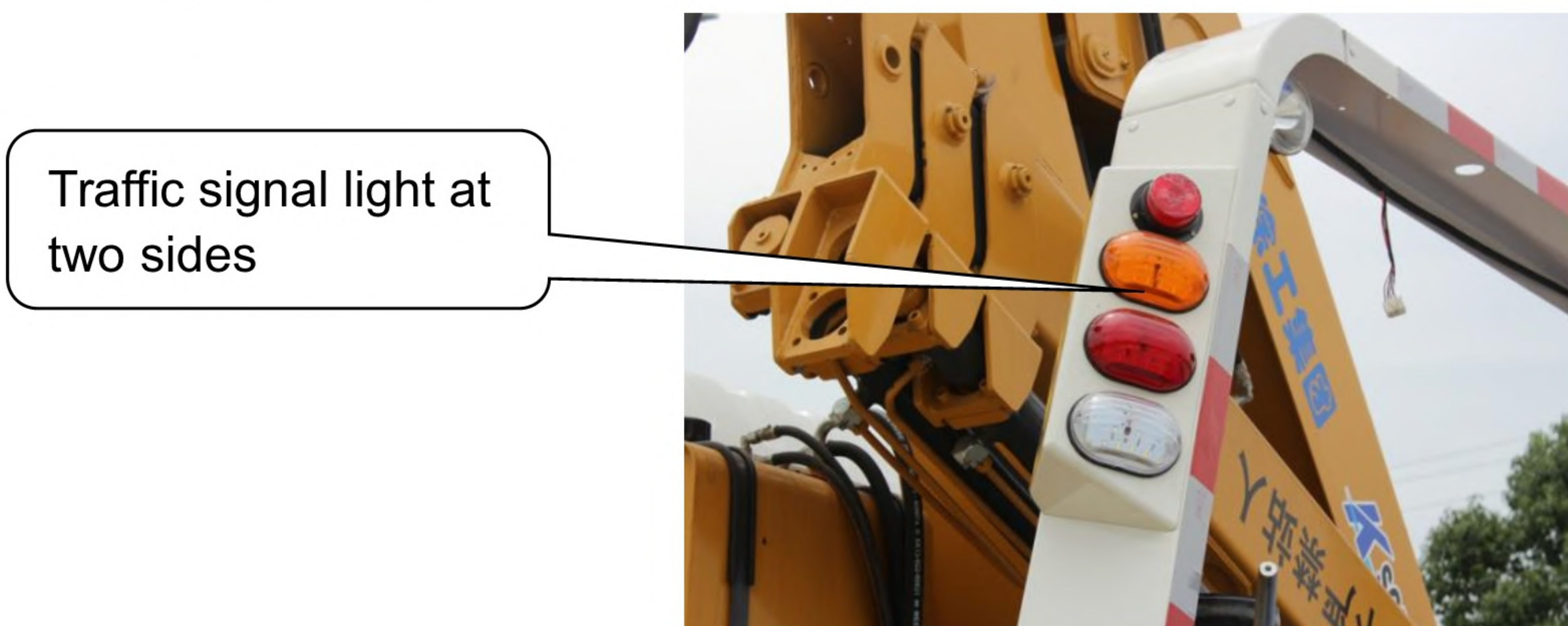

3. Capstan and rope

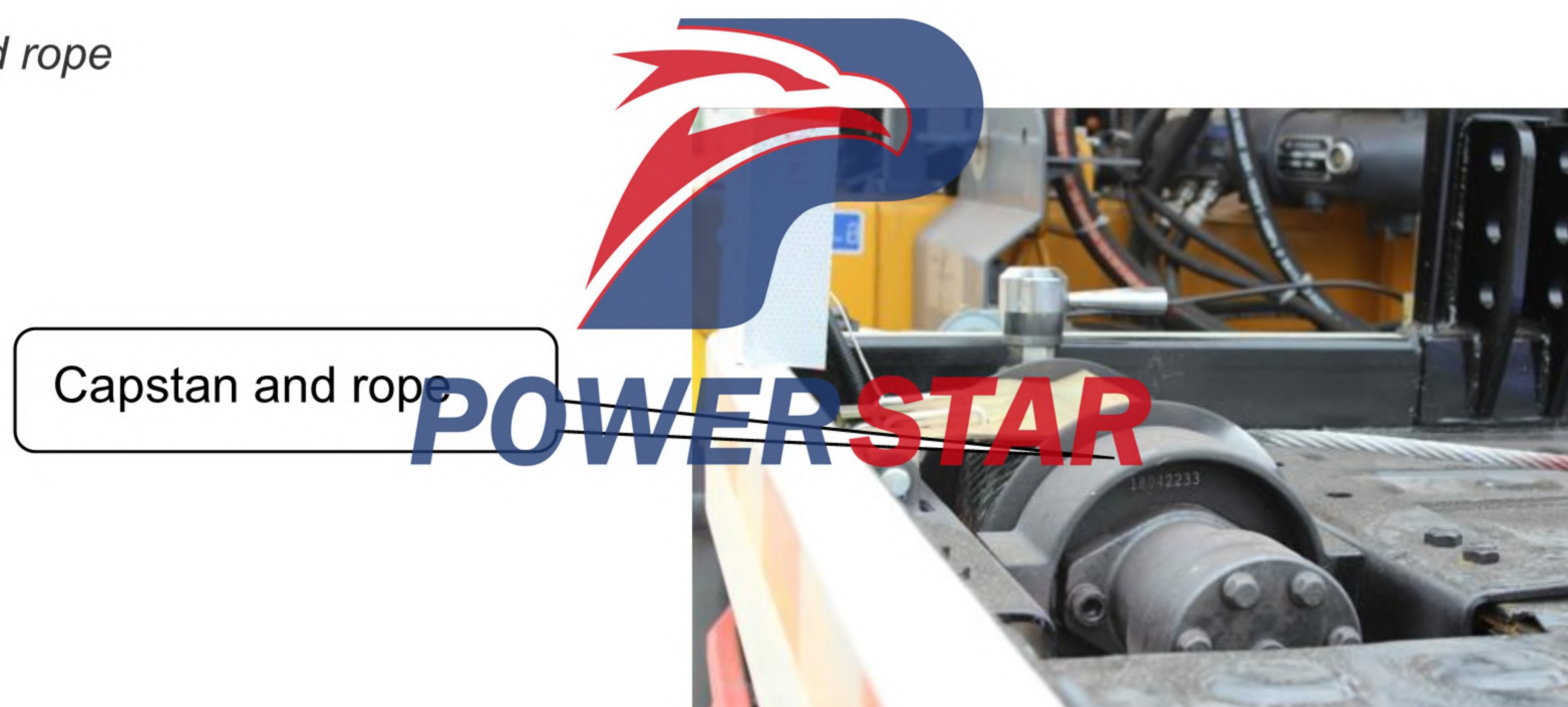

4. Platform

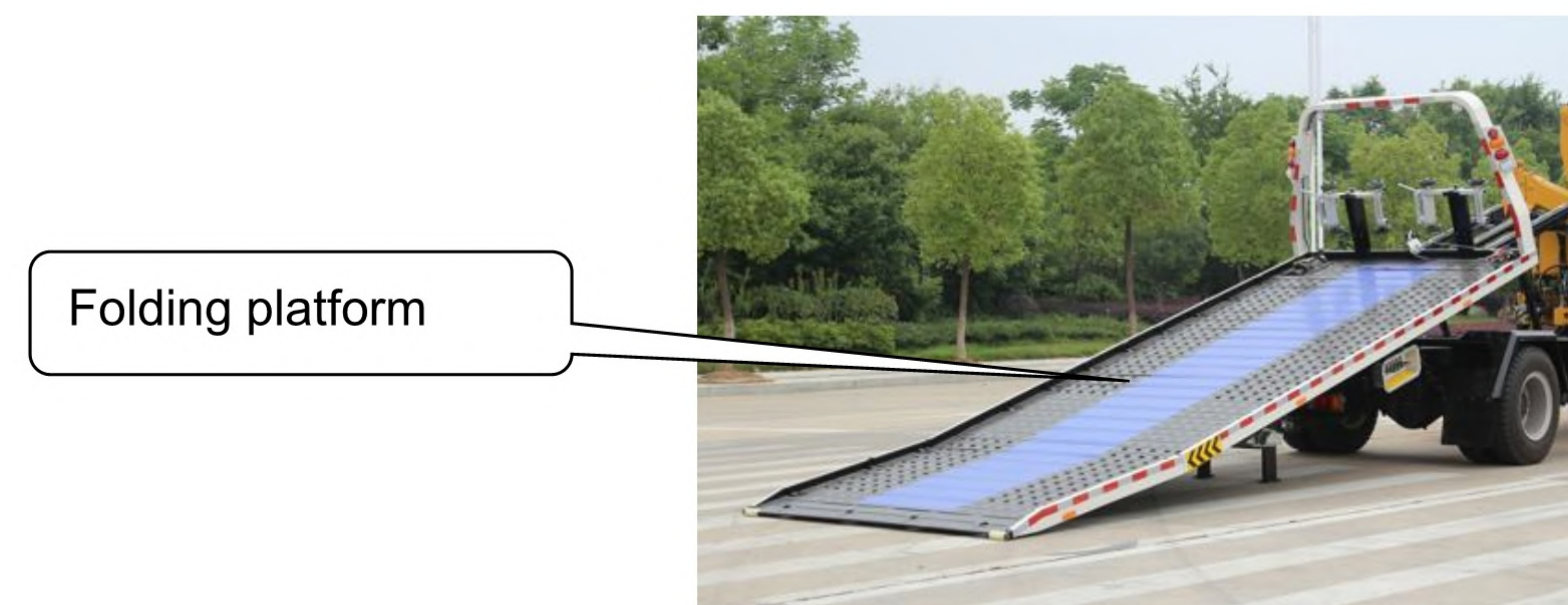

5. Side warning lamps (each side has three units)

www.isuzutrucks.cn.com

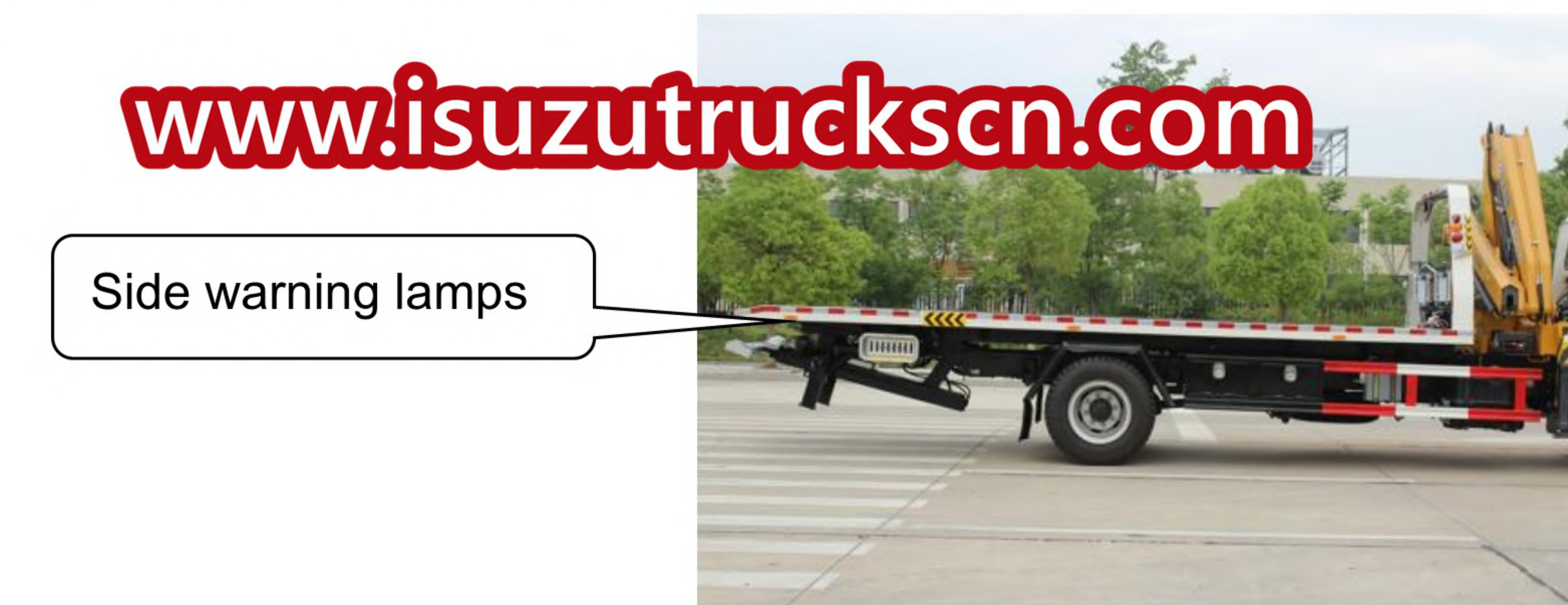

6. *Wheel bracket*

Wheel bracket



7. *Operation Joysticks*

Operation Joysticks



8. *Side fence (Installed at two sides)*

Side fence



9. *Tool box and accessories*

Tool box

www.isuzutrucks.cn.com



Chapter 4, Wrecker Truck with Crane Working Principles

The operator should fully understand Whole Structure and Working Principle for Isuzu 4*2 Wrecker Truck with Crane before any operation. Only trained person can operate this vehicle properly and to prevent unnecessary accidents and equipment damage.

i , How is the wrecker truck with crane working?

The wrecker truck with crane is refitted based on the Isuzu 4*2 left hand drive chassis. The refit part mainly included 5Tons knuckle boom crane and platform. The engine power transit from PTO on gearbox to hydraulic oil pump, then hydraulic oil through the pump start from all control valves to hydraulic cylinders and hydraulic motors, which can make all system working normally.



- 5Tons knuckle boom crane assembly: which can be operated by crane control box, the working is relatively independent.
- Auxiliary frame is the base of all superstructure components, which can distribute the concentrated load of each component uniformly to the chassis frame, and improve the chassis bearing condition.
- Platform is the main part of the wrecker truck. The platform move backwards and tilting suitable angle, make sure the rear on land. Then the capstan and rope can towing cars loading on the platform, all hydraulic cylinders support the whole loading process.
- Wheel bracket mainly used for rescue work. Which make the wrecker truck rescue two cars at one time.
- Large toolbox as standard installed below platform, which mainly used for storage all necessary rescue accessories.
- Operation Joysticks installed at two side of the platform, which can make the wrecker truck working by using hydraulic joysticks. Also two sides Operation Joysticks design can make sure operator always at safety sides.
- Safety warning lamps installed on top of the platform, which can not only warning others during working, but also can protect the driver.

ii **How to operate wrecker truck with crane?. (Very Important)**

1. Refer to Chapter 3 and get more information about superstructure component.

At co-driver side, near the operation joysticks installed Red Switch

**Please Note: When switch is PARALLEL with platform, wrecker platform working (Figure 1);
When switch is VERTICAL with platform, knuckle crane working (Figure 2).**



Figure 1: Red Switch parallel with platform

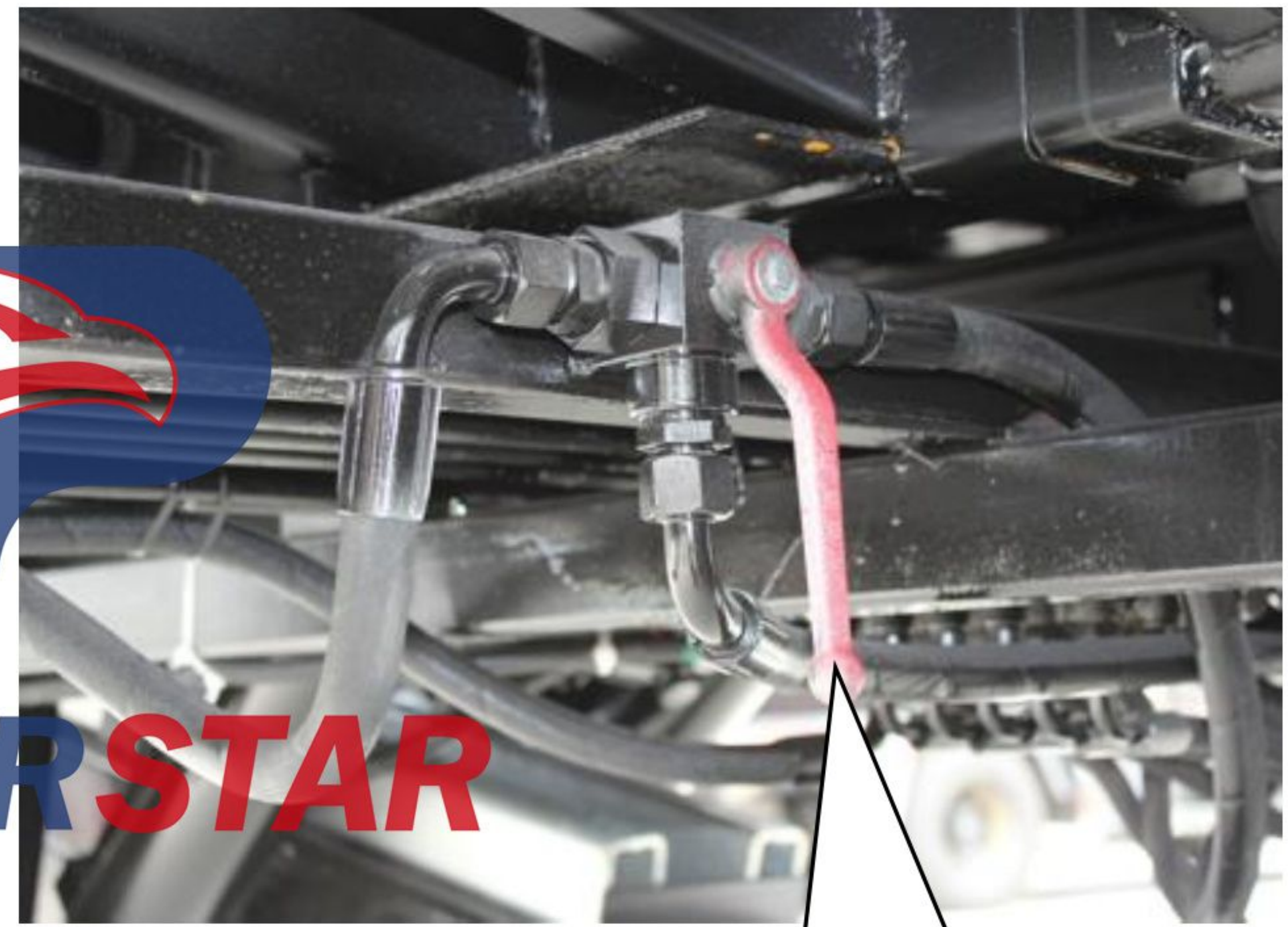

Figure 2: Red Switch vertical with platform

2. **How to operate the 5Tons knuckle boom crane:**

a) Red Switch turns to vertical position as below picture showing.

Red Switch vertical with platform

www.isuzutruckscn.com



b) Kindly refer to the specified Manual of Loader Crane, model SQ5ZK2Q (New model SQZ105-3).

3. **How to operate the wrecker platform:**

a) Red Switch turns to parallel position as below picture showing.

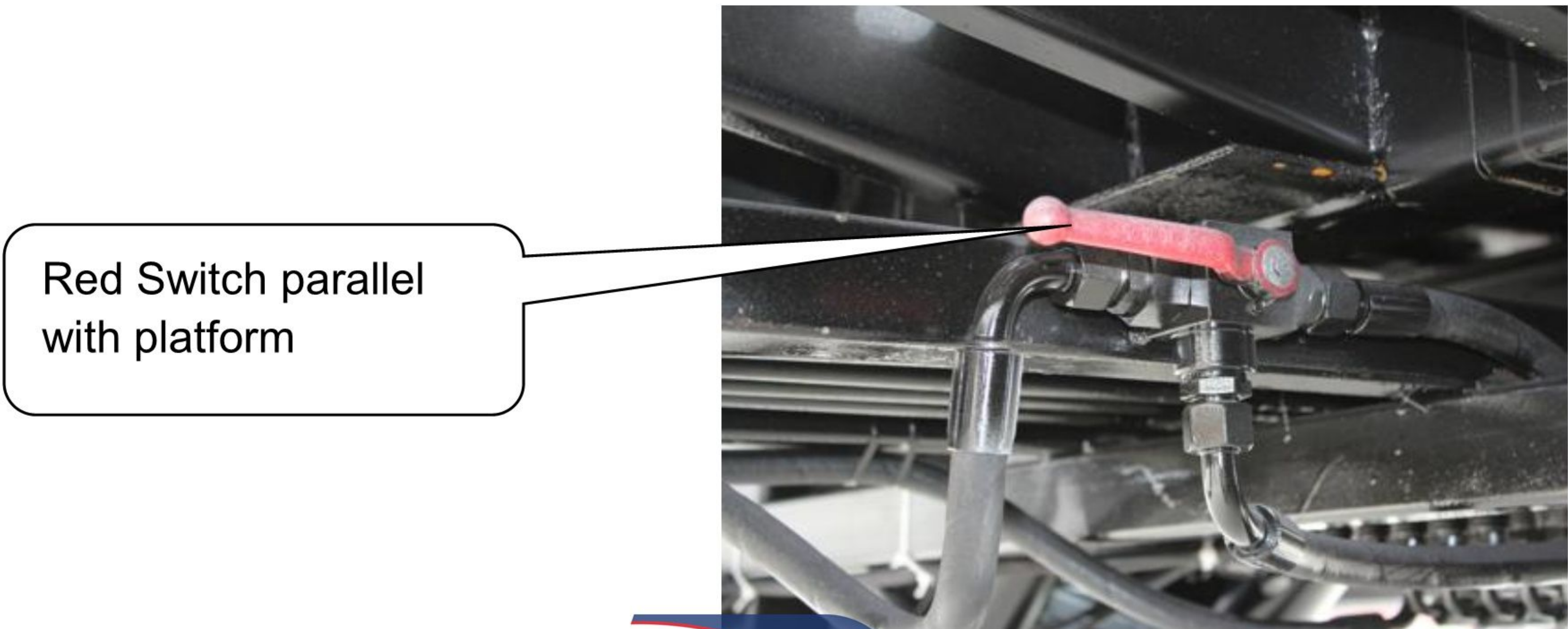

b) Kindly refer to below wrecker truck working principle drawing.

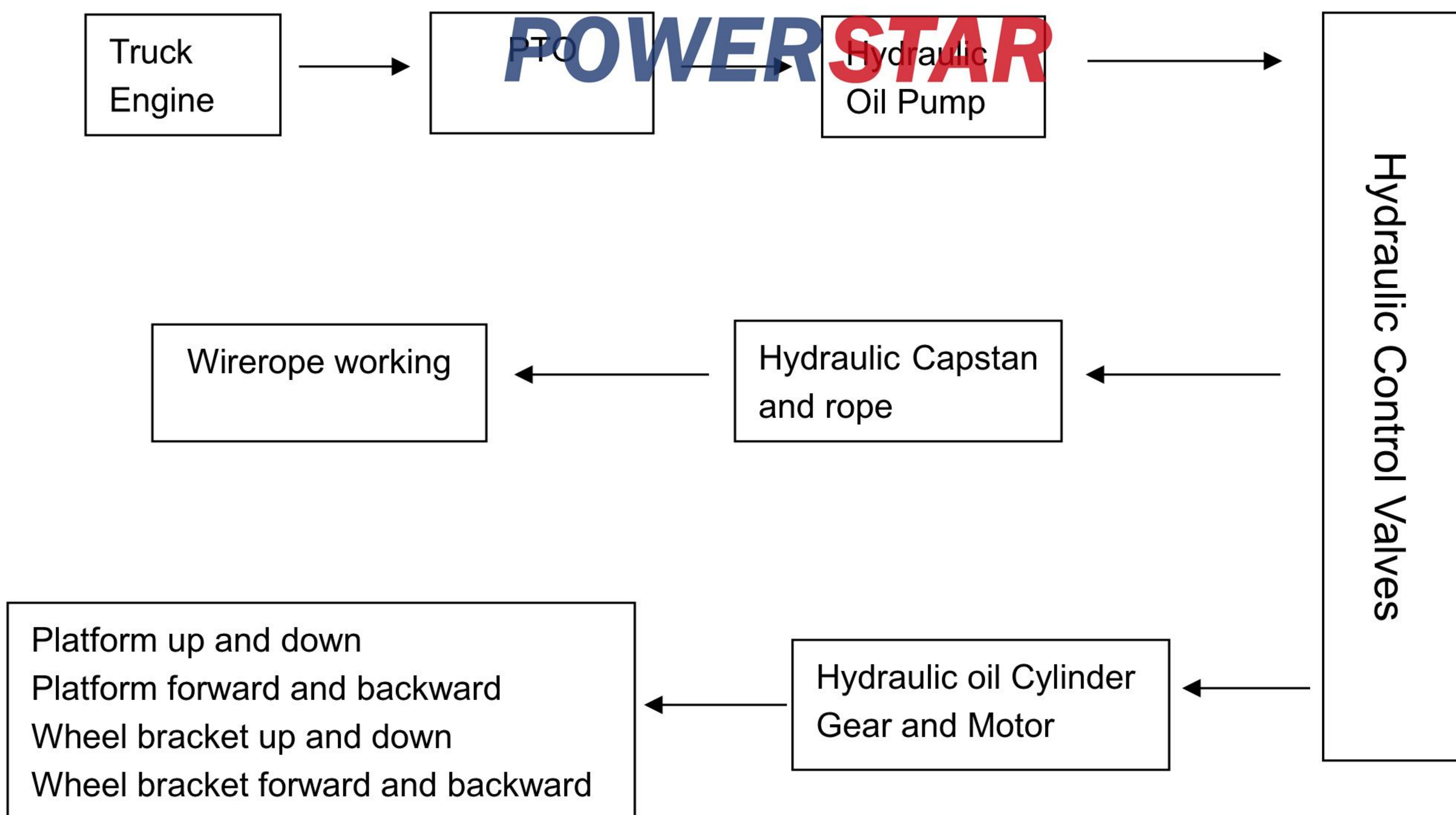

c) Refer to the Operation Joysticks English Guidance to operate the wrecker platform.

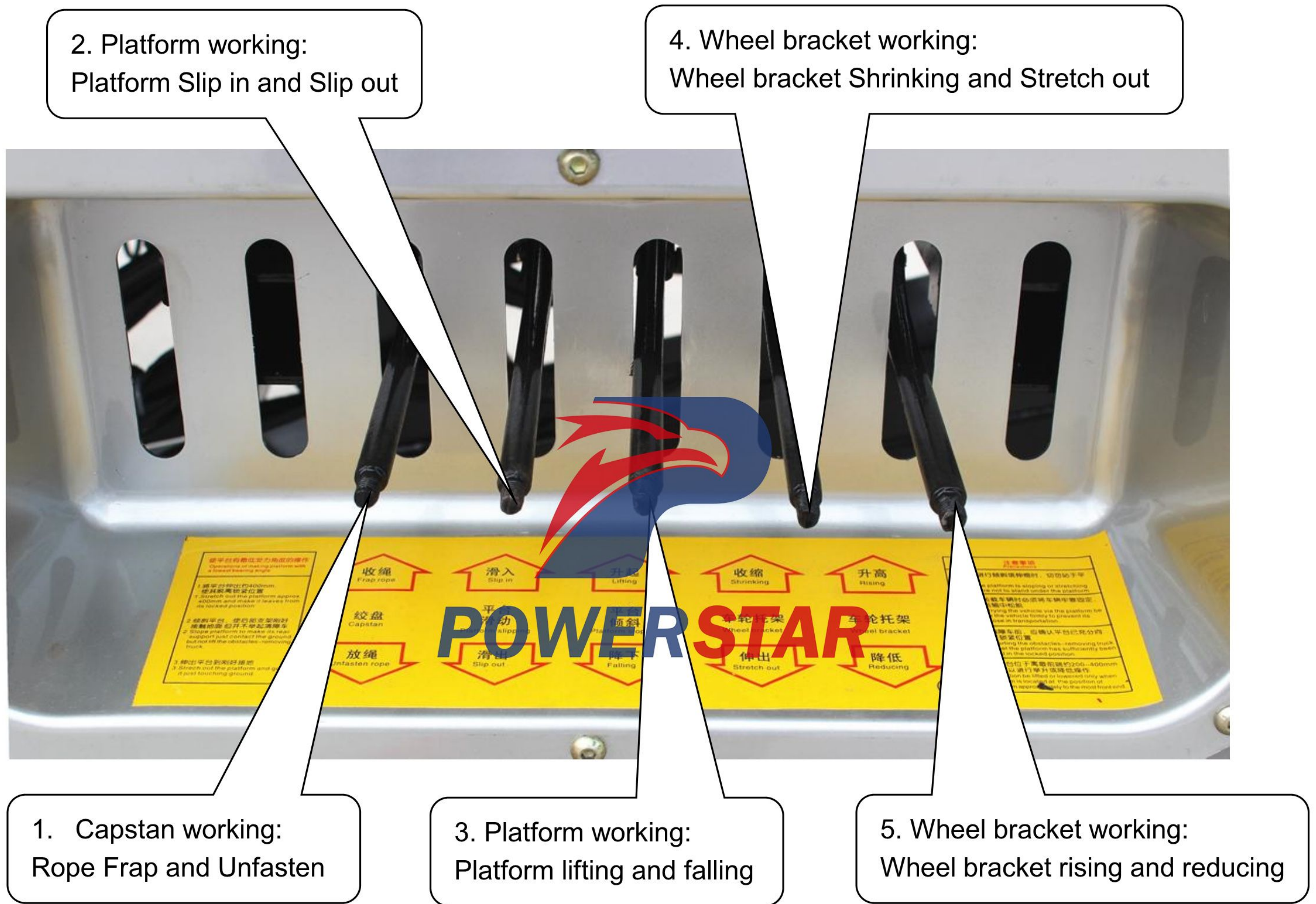

d) Operate Joystick 2 & 3, the Platform working (**Loading First Car**):

Press Joystick 2 to Slip Out position, the platform move backward, which move short distance; release Joystick 2 and press Joystick 3 to Lifting position, the platform move upward till to the extreme position; then release Joystick 3 and press Joystick 2 again till the platform touch the ground.



(Picture showing is the position that cars can start loading on platform)

e) Cars loading on the wrecker truck platform.

Option 1: Car with power: Drive directly to the platform, then use bandage fasten on the platform.

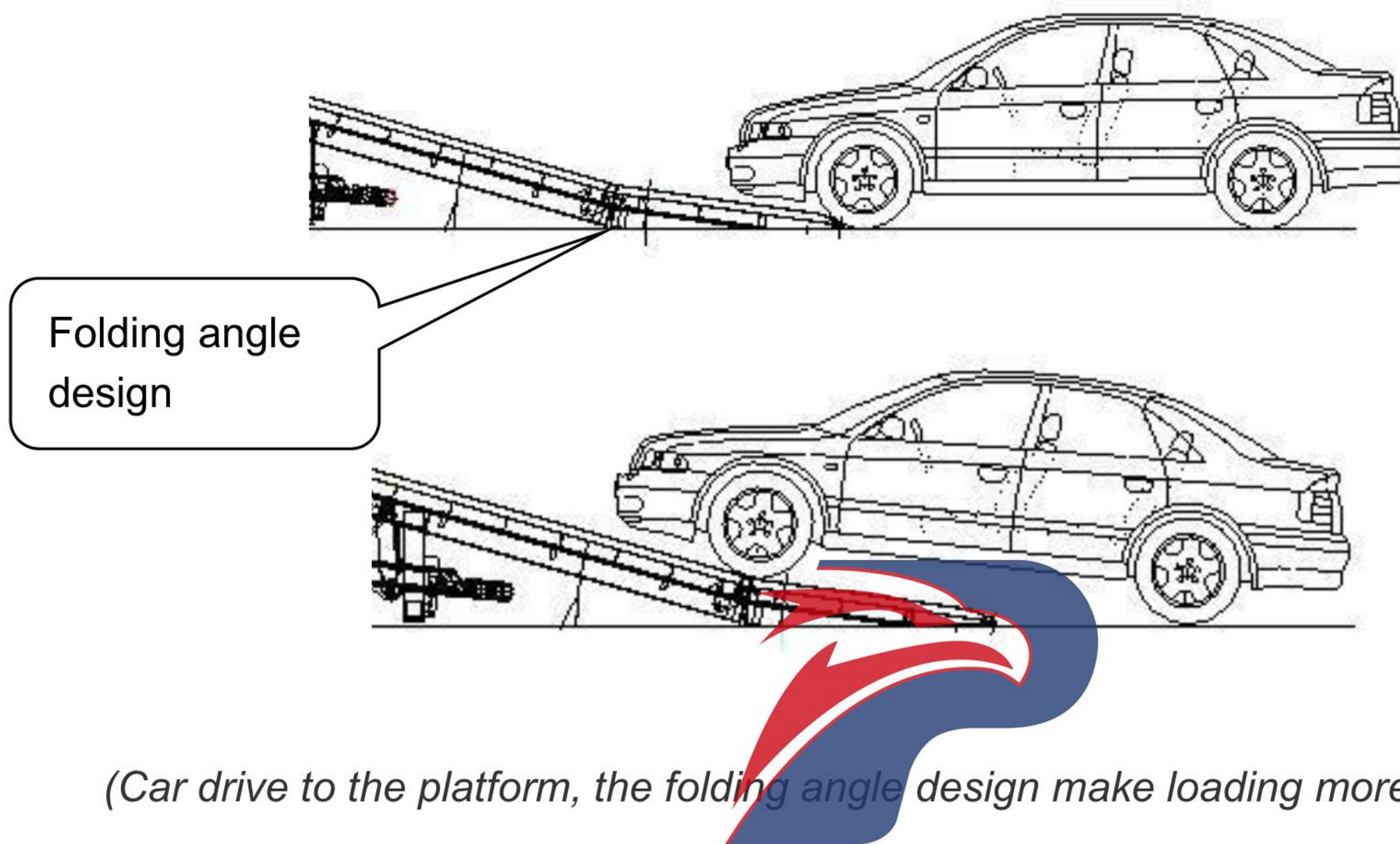

POWERSTAR

Bandage as necessary accessories to fasten car on platform



Capstan and rope also used to fasten car on platform



www.isuzutrucks.cn.com

Option 2: Car with no power: Use capstan and rope towing cars loading to the platform, then use bandage fasten on the platform.

Capstan and rope hook towing the cars loading on platform



Note: Capstan and rope working introduction



(Driver Position-----Co-Driver Position)

When switch turn to Driver Position, Capstan and rope working manually

When switch turn to Co-Driver Position, Capstan and rope working hydraulically

- f) *When cars well fasten on the platform, Operate Joystick 2 & 3, the Platform working:
Press Joystick 2 to Slip In position, the platform move forward, which move short distance; release Joystick 2 and press Joystick 3 to Falling position, the platform move downward till to the extreme position; then release Joystick 3 and press Joystick 2 again till the platform back to normal model.*

- g) *Operate Joystick 4 & 5, the Wheel Bracket working (**Loading Second Car**):
Press Joystick 5 to Falling position, the wheel bracket move downward, which move short distance; release Joystick 5 and press Joystick 4 to Stretch Out position, the wheel bracket move out till to the extreme position; then release Joystick 4 and press Joystick 5 again till the wheel*

bracket landing on the ground.

Picture showing Wheel Bracket landing on the ground



h) The Wheel Bracket can be adjustable to be suitable for many sizes of wheels.

Tire holding system is moveable and adjustable when using

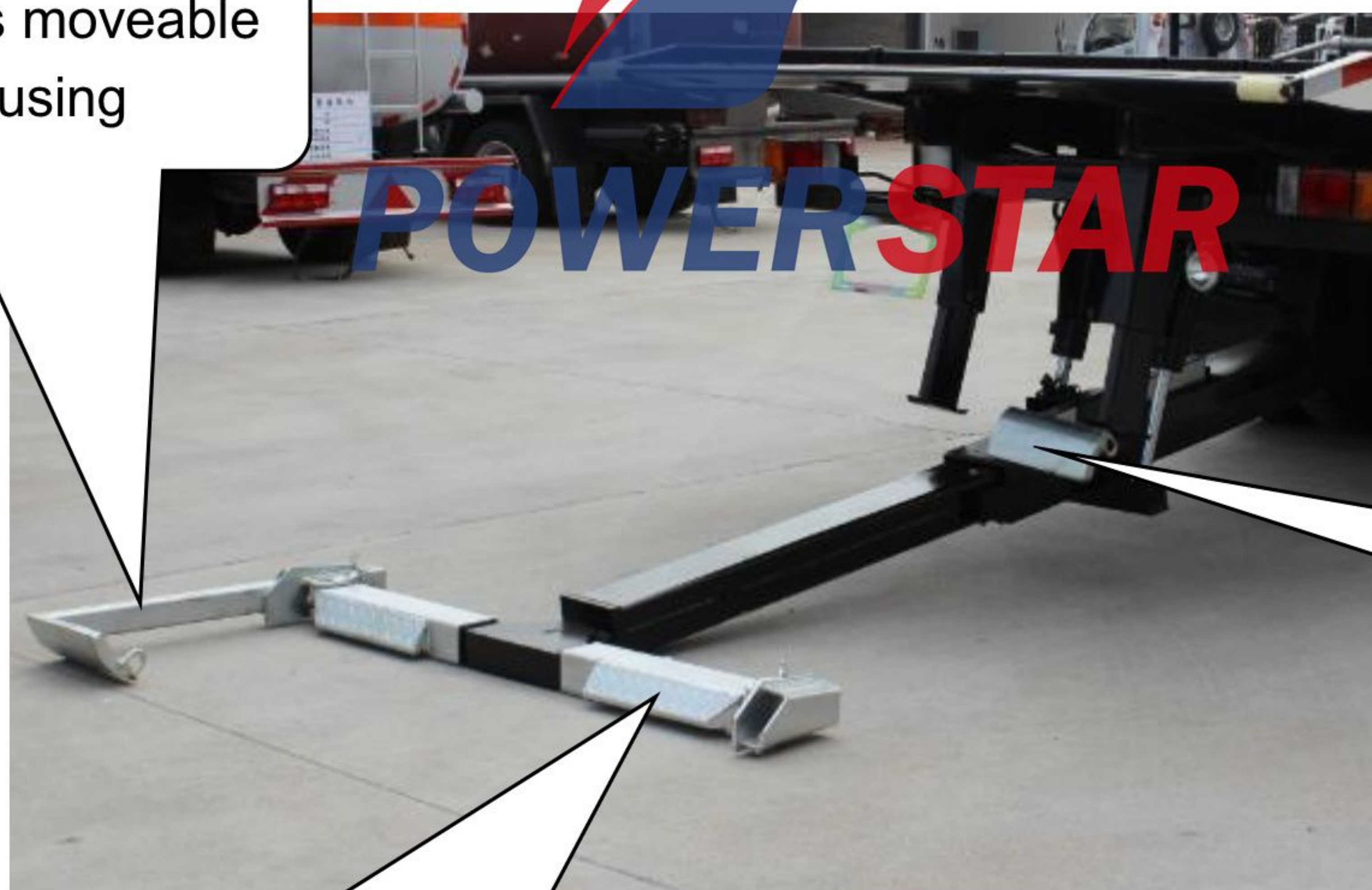

Tire holding system kept position when not using

The bracket can stretch out to suit for different sizes of tires

i) When towing car well fixed on wheel bracket, Operate Joystick 4 & 5, the Wheel Bracket working: Press Joystick 5 to Rising position, the wheel bracket move upward, which move short distance; make sure the car easy for towing.

Chapter 5, Others for Attention

After carefully reading the above information, you must be well known how to use the ISUZU 4*2 Wrecker Truck with Crane; below show some parts you need to pay attention while using the truck.

1. New Truck for Attention

As the new truck needs to pass the run-in period smoothly, so please take note for truck at the beginning of 100 hours:

- Lifting weight and Towing weight not exceed 70% of the rated weight, and maximum rope towing weights not exceed 70% of the rated one.
- Carefully checking all joints fasten situation before and after each operation.



2. Truck Driving for Attention

- All system retracts to initial position, the operation Joysticks at middle position, and PTO must shut off.
- Wheel Bracket position cannot be too low, because it is not safety for driving.
- When wrecker truck full loading, the driving speed should be less than 30km/h, the speed should be lower special on turning position, going up and down position or in bad situation. Sharp turn and brake is forbidden.
- When reversing, the included angle for truck and car should be less than 70° , otherwise will damage the car.

3. Platform working for Attention

- Strictly following the Operation Guidance for using. No overloading.
- Before lifting the platform, press Joysticks 2 to Slip Out position, make sure the platform move backward firstly, which can drag the roller off the limit frame. When platform out of the limit frame, then can start lifting.
- Similarly, when platform falling down, press Joysticks 2 to Slip In position, make sure the platform move forward firstly, then falling to extreme position and move forward to initial place.
- Make sure the Wheel Bracket at initial position before lifting the platform.

4. Wheel Bracket working for Attention

- *Strictly following the Operation Guidance for using. No overloading.*
- *The wheel bracket is adjustable and moveable, which can make the bracket suitable for different tires, but overloading is strictly forbidden.*

5. Capstan and rope working for Attention

- *When capstan and rope towing cars loading on the platform, the rear legs on wheel bracket should be on solid ground.*
- *Towing position should be at rear of the platform, the towing angle less than 20 °*
- *Capstan under working condition, the rope should left 4-5 rings.*

6. Hydraulic system working for Attention

- *When operate the hydraulic control system manual joysticks and acceleration cable, should not drag too hard.*
- *Hydraulic oil should be same brand, mixing using is forbidden.*
- *When hydraulic oil temperature exceed 70 °C, the work should be stop.*



POWER STAR



Chapter 6, Troubleshooting

Items	Trouble	Reason	Method
1	Hydraulic oil leakage	<ol style="list-style-type: none"> 1. Joint loosen 2. Sealing parts damage 3. Pipeline break 	<ol style="list-style-type: none"> 1. Fasten joint 2. Replace new seals 3. Change new pipes
2	Hydraulic oil pressure lower	<ol style="list-style-type: none"> 1. Hydraulic oil level too low 2. Suction pipe blocked 3. Oil pump damage or serious leakage 4. Overflow valve low open pressure 5. Oil pipe or actuator serious leakage 6. Pressure gauge damage (No data) 	<ol style="list-style-type: none"> 1. Add more hydraulic oil 2. Maintenance suction pipe 3. Maintenance oil pump 4. Adjust to suitable pressure 5. Maintenance oil pipe and actuator 6. Maintenance pressure gauge
3	Oil road too noisy	<ol style="list-style-type: none"> 1. Air exist inside of pipe 2. Suction pipe air leakage 3. Oil temperature too low 4. Filter blocker 5. Hydraulic oil not enough 	<ol style="list-style-type: none"> 1. Multiple working to exhaust air 2. Maintenance suction pipe 3. Idle working or change low viscosity hydraulic oil 4. Change filters 5. Add hydraulic oil
4	Oil road temperature too high	<ol style="list-style-type: none"> 1. Serious inside leakage 2. Overflow pressure too high 3. Working temperature too high or long time working 4. Balanced valve blocked 	<ol style="list-style-type: none"> 1. Maintenance actuator 2. Overflow pressure adjust to rated value 3. Stop working 4. Clean or change balanced valve
5	Pressure instability	<ol style="list-style-type: none"> 1. Overflow valve damping hole blocked or damping spring damaged 2. Balance valve damping hole blocked 3. Air exist in oil road 	<ol style="list-style-type: none"> 1. Cleaning or change new overflow valve 2. Cleaning or change new balance valve 3. Exhaust air
6	High oil pressure even unloading	<ol style="list-style-type: none"> 1. Oil road blocked 2. Filters blocked 	<ol style="list-style-type: none"> 1. Cleaning the oil road 2. Cleaning or change new filters
7	Oil cylinder shaking	<ol style="list-style-type: none"> 1. Air exist in air road 2. Balance valve damping hole blocked 	<ol style="list-style-type: none"> 1. Multiple working to exhaust air 2. Clean or change balanced valve
8	Accelerator not working	<ol style="list-style-type: none"> 1. Accelerator cable too long 2. Accelerator cable stuck 3. Engine throttle is locked 	<ol style="list-style-type: none"> 1. Adjust the cable length 2. Maintenance the accelerator cable 3. Unlocked the engine throttle

Chapter 7, Accessories

Items	Name	Picture	Quantity	Remark
1	Dragging fork seat		2 units	
2	Dragging fork		2 units	
3	L-shape tire holding system		2 units	Storage on the Wheel Bracket
4	Bandage		2 units	
5	V-shape hook		1 unit	

www.isuzutrucks.cn.com

6	Towing trailer		2 units	
7	Standard ISUZU truck Tools		1 set	
8	Customer ordered spare parts			

POWERSTAR